

DTS 307

DIN – Rail Mounted, Ultra-Compact Revenue Grade Electrical Sub-meter



1	PRODUCT OVERVIEW	3
1.1	SUPPLIED ITEMS	4
1.2	DOCUMENT CONVENTIONS	4
1.3	PRODUCT SPECIFICATION	5
1.3.1	<i>Current Inputs</i>	5
1.3.2	<i>Service Type</i>	5
2	INSTALLATION	6
2.1	ENVIRONMENT	6
2.2	SAFETY GUIDELINES	6
2.3	PRODUCT DIMENSIONS	7
2.4	MOUNTING REQUIREMENTS AND GUIDELINES	7
3	CONNECTING TO THE DTS 307	9
3.1	WIRING VOLTAGE AND CURRENT INPUTS	9
3.1.1	<i>Wiring Examples</i>	9
3.2	CONNECTING MULTIPLE LOADS	11
3.3	AUXILIARY POWER	12
4	DTS 307 COMMUNICATIONS INTERFACE	13
4.1	RS-485 2-WIRE COMMUNICATIONS	13
4.2	KWH PULSE OUTPUT (MODEL DEPENDENT)	14
5	LED DEFINITIONS	14
5.1	STATUS LED	14
5.2	REMOTE LED	15
6	INSTALLATION OF DTS CONFIG AND MONITORING SOFTWARE	15
7	MAINTENANCE AND SERVICE	15
7.1	CLEANING INSTRUCTIONS	15

1 PRODUCT OVERVIEW

The One Revenue Grade Meter for all Applications.

Our DTS 307 or DTS 307/1 energy sub-meter is one of the most versatile meters available on the market.

The standard DTS 307 is a full 3-Phase measurement RGM. If only a single phase 2-Wire system needs to be measured, the single channel DTS 307/1 is also available.

The DTS 307 can operate in any environment, requires no external power source to operate, and works with all UL or ETL listed 333mV current transformers.

For ease of installation, the DTS 307 is designed to be ultra-compact and fit into most DIN-rail systems.

Some of the exciting features provided with the DTS 307 are

- Easy to attach pluggable terminals
- Modbus RTU or BACnet MS/TP depending on model
- Auto-topology Phase Detection
- Automatic correction of reversed field mounted CTs

For remote configurability, your DTS 307 comes with our freely downloadable *DTS Config* software tool

The DTS 307 is certified to ANSI C12.20 Class 0.5 Revenue Grade.

Also, if in the future, you decide to integrate renewable energy sources, the DTS 307 will conveniently operate as a Bi-Directional **NET** meter. Easily integrates with Building Automation Systems and Energy Monitoring Software.

Designed and Manufactured in the USA and complies with the Buy American Provisions of ARRA Section 1605.

Thank you for choosing Measurlogic and a meter from the DTS Family.



NOTE

Both the DTS 307 and DTS 307/1 variations will be generically referred to as the "DTS 307" in this document, except where it is important to distinguish between the two models.



1.1 Supplied Items

Check that the meter and equipment matches your order specifications and has not been damaged during shipping. Verify that the following item(s) match with the corresponding model from the data sheet:

- Installation Guide
- DTS 307 power & energy meter
- 10-Pin green pluggable screw terminal connector for Voltage and Aux Power/Digital Output
- 6-Pin green pluggable screw terminal connector for Current inputs
- 3-Pin green pluggable screw terminal connector for Remote RS-485 Communications

1.2 Document Conventions

SYMBOLS

	<p>ATTENTION – PLEASE CONSULT THE INSTALLATION MANUAL</p>
	<p>WARNING – RISK OF ELECTRICAL SHOCK</p>

1.3 Product Specification

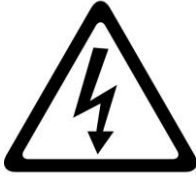

WARNING
<p>Measurement Category III DTS 307 is intended for 480V L-L use DTS 307/1 is intended for 240V L1-L2 use Do NOT exceed this usage</p>
<p>Use the model number of the DTS 307 to verify that it is suitable for the voltage, type and category of the installation.</p>
<p>Failure to use the correct CT's, and/or connecting too high a voltage can result in death or personal injury and may permanently damage the DTS meter.</p>

The model number for the normal three-phase DTS 307 is:

DTS 307 - Ax-xx-x-F

For applications where only single channel measurements are needed, the model number is:

DTS 307/1 - Ax-xx-x-F

1.3.1 Current Inputs

Current Inputs	Value	Description	Notes
A	3	333mV CT	Any 333mV CT is acceptable
	9	Rope CT	Only use the CT's that came with the unit

1.3.2 Service Type

Service Type	Value	Description	Neutral Required	Neutral Optional
F	N	(1P 2W, 1P 3W, 3P 4W) 120 – 277Vac L– N	•	
	2	(3P 3/4W) 208 – 240 Vac L– L <i>(for DTS 307)</i> (1P 2W) 120 – 277 Vac L1–L2 <i>(for DTS 307/1)</i>		•
	A	Any of the above services (See 3.3 for details)		•

2 INSTALLATION

2.1 Environment

Operating Temperature:	-31°F to 158°F	(-35°C to 70°C)
Storage Temperature:	-40°F to 185°F	(-40°C to 85°C)
Relative Humidity:	5% to 95%	(non-condensing)
Operating Altitude:	Up to 2,000m	

2.2 Safety Guidelines



WARNING

The following installation instructions are intended for qualified personnel only. To reduce the risk of electrical shock and personal injury, do not perform additional tasks not stated in this procedure unless you are qualified to do so.

Always adhere to the following safety guidelines:

- Only qualified personnel or **licensed electricians** should handle the installation. Input voltages to the DTS 307 can be hazardous.
- Follow all applicable local and national electric codes.
- Verify input voltage and current are within thresholds for the specific DTS 307 model. (See Product Specification on page 5)
- **Only Current Transformers that are listed to UL 2808 for use in 250Vac or 600Vac line-to-line circuits (as appropriate for the installation) may be used with this meter.**
- **ONLY USE CURRENT TRANSFORMERS WITH OUTPUTS THAT ARE COMPATIBLE WITH THE MODEL OF DTS 307 (SEE SECTION 1.3.1). THE USE OF ANY OTHER CURRENT TRANSFORMER CAN RESULT IN PERMANENT DAMAGE TO THE DTS 307.**
- Avoid any electrostatic discharge prior to working on the DTS 307 by first touching a grounded structure prior to handling the DTS 307.
- Before applying power make sure that all current transformer and voltage connections are securely connected to the input terminals of the DTS 307.
- If the DTS 307 is installed incorrectly any built-in safety features may no longer be functional.
- Before handling the DTS 307 ensure that all power running to the DTS 307 is removed.
- The DTS 307 MUST be mounted in a NEC compliant enclosure suitable for the application's environmental conditions.
- The DTS 307 may be used outdoors if housed in an outdoor rated enclosure that prevents water ingress, such as a NEMA Type 3R / IP14 or higher that is suitably rated for the application.
- The enclosure must be equipped with a **user supplied lock** or other means to prevent unauthorized access.

2.3 Product Dimensions

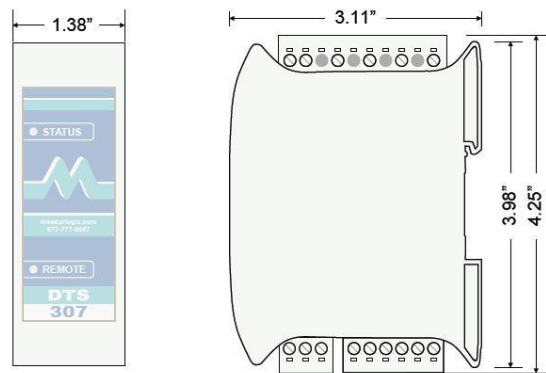

2.4 Mounting Requirements and Guidelines



WARNING

To reduce the risk of electric shock, always open or disconnect circuit from power distribution system (or service) or building before installing or servicing the meter and/or its current transformers.

When mounting the DTS 307 make sure to follow these guidelines:

- Always open or disconnect circuit from power distribution system (or service) or building before installing or servicing the meter and/or its current transformers.
- Mount the DTS 307 as close as possible to the electrical panel being monitored.
- Make sure that there is at least 4" of clearance above and below the DTS 307 for wiring and connector clearance and ¼" of clearance on both sides for cooling.
- Position the DTS 307 such that the labeling can be read from the upright position.
- Only UL or ETL rated conduits and glands should be used.
- It is recommended that two separate conduits be run for voltage and current connections.
- Use Copper Conductors ONLY.
- Only Current Transformers that are listed to UL 2808 for use in 250Vac or 600Vac line-to-line circuits (as appropriate for the installation) may be used with this meter.
- The Current Transformers may not be installed in equipment where they exceed 75% of the wiring space of any cross-sectional area within the equipment.

- Restrict installation of Current Transformer in an area where it would block ventilation openings.
- Restrict installation of Current Transformer in an area of breaker arc venting.
- Not suitable for Class 2 wiring methods. Not intended for connection to Class 2 equipment.
- Secure Current Transformers and route conductors so that they do not directly contact live terminals or busses.
- **User Supplied** UL or ETL certified 2A fast-blow fuses need to be installed between the Voltage inputs of the DTS 307 and panel being monitored. Recommended Littelfuse BLS002 or equivalent.
- 14 to 12 AWG wire should be used for the voltage and ground with 300V or 600V insulation depending on installation type and according to the table below.
- A UL or ETL certified 600V circuit-breaker or equipment switch must be installed as a disconnecting device for the DTS 307, and must be positioned within easy reach of the DTS 307. The circuit-breaker or equipment switch employed for this disconnecting device shall meet the relevant requirements of IEC 60947-1 and IEC 60947-3, be suitable for the application, and **MUST** be clearly marked as being **"the disconnecting device"** for the DTS 307. See table below for the breaker and wire gauge to use.

WIRE & BREAKER GUIDE	
Gauge of Wire	Recommended Breaker
14 AWG	15 Amp 600V 3-Pole Breaker
12 AWG	20 Amp 600V 3-Pole Breaker

3 CONNECTING TO THE DTS 307

3.1 Wiring Voltage and Current Inputs



ATTENTION

Examine the model number of each of your meters to ensure that they are suitable for the type and voltage of the service you are connecting to. See section **Error!** **Reference source not found.** for details.

Note: CTs should be connected to the same panel as the voltage connections.

3.1.1 Wiring Examples

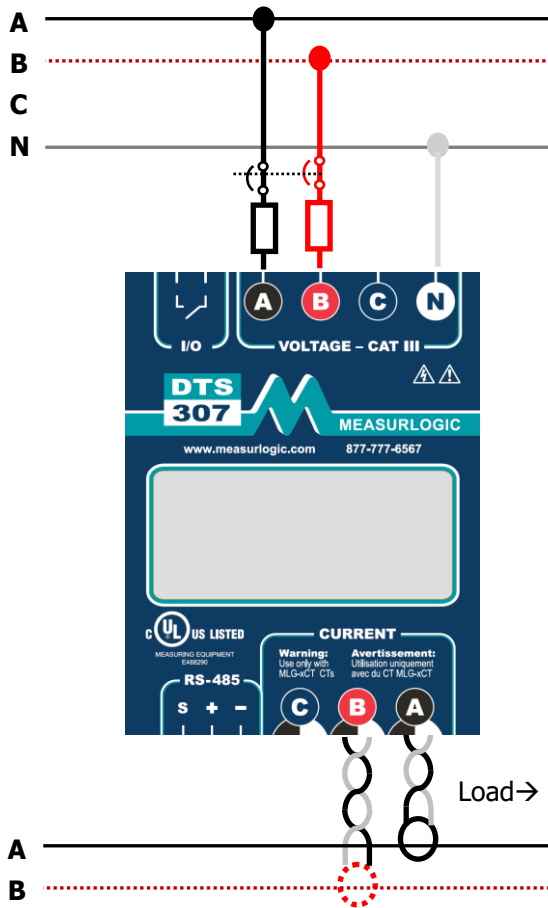

DTS 307
Single Phase 2/3 Wire

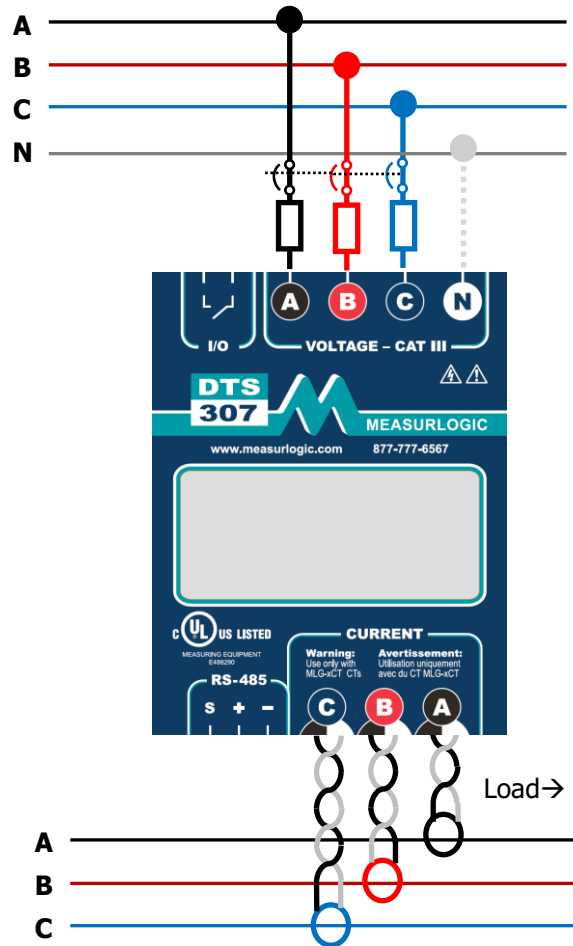

DTS 307
3-Phase with Optional Neutral
(Model Dependent)

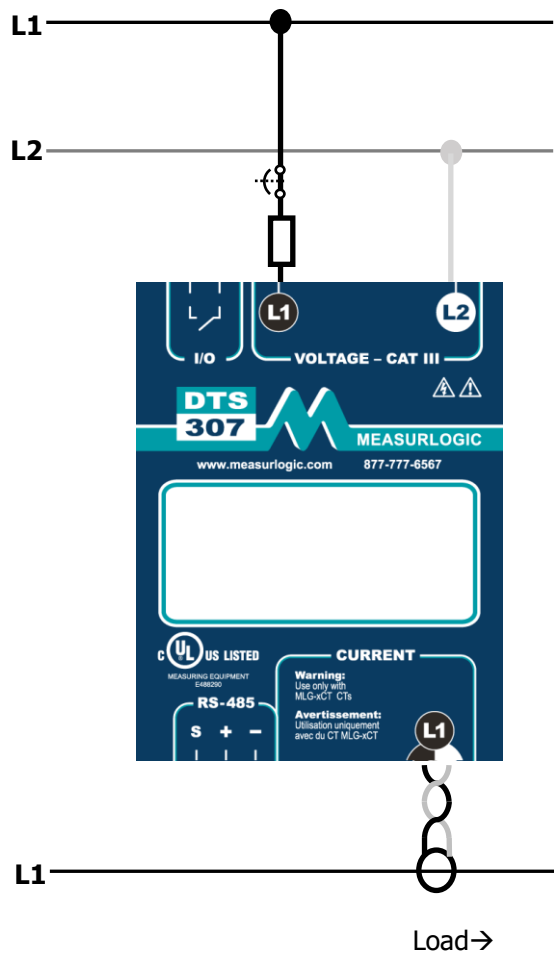

DTS 307/1
Single Phase 2-Wire ONLY

3.2 Connecting Multiple Loads

The DTS 307 allows for ease and flexibility when monitoring multiple branches. The DTS 307 allows multiple CT sensors to be connected in parallel via the green pluggable screw terminal.

When using parallel CT sensors, the following guidelines must be followed to ensure accurate measuring.

- All CT sensors must have a 333mV output.
- All CT sensors must be of the same manufacturer/model number and current rating.
- A full set of CT sensors must be used for each load.
- The pair of wires from the CT sensor to the green pluggable screw terminal must be twisted.
- All CT sensors must be terminated at the green pluggable screw terminal.
- A maximum of 3 loads can be monitored at once (Contact Measurlogic if more than 3 loads must be monitored).
- The measured phase current will be the total current across all the loads on that phase.
- The CT primary rating for the DTS 307 must be set to the **CT rating * Number of CT sets**.
- The example below shows how to calculate the service current for figure 3.2.1.

Service Current for Figure 3.2.1	
Number of CT Sensor Sets	2
CT Rating	100 Amps
CT Primary	200 Amps

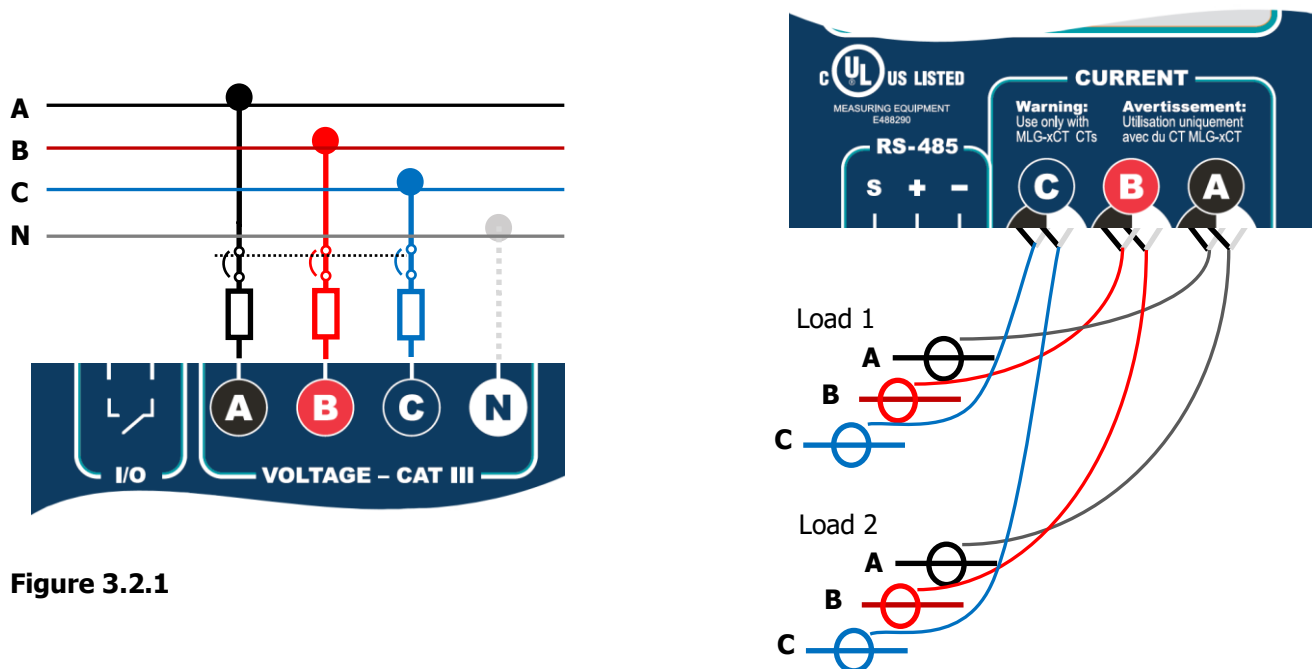

Figure 3.2.1

3.3 Auxiliary Power



ATTENTION
<p>DTS 307 meters that have an "A" in the Service Type field of the model number (as shown in section 1.3.2) require an external 24Vac/dc auxiliary power supply to operate.</p>
<p>A separate IEC 60950 compliant isolated 24Vac/dc power supply MUST be used to power these meters.</p>

- Connect the external IEC 60950 compliant isolated power supply to the two 24Vac/dc terminals on the DTS 307 meter as shown on the meter label and in the diagram below.
- For clarity, the meter voltage terminal and the CT sensors connections are not shown on the diagram below. Please see sections 3.1 and 3.2 for these connection details.

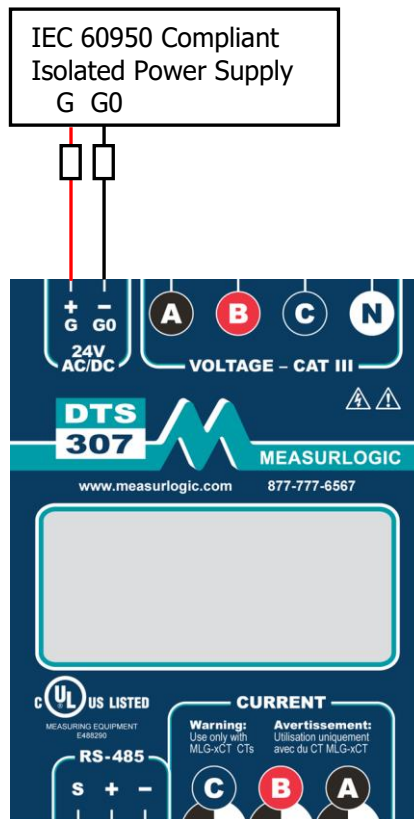

4 DTS 307 COMMUNICATIONS INTERFACE



SAFETY WARNING

Ensure that **all external devices** that are connected to either or both of the **RS-485 communications bus**, and/or the **digital solid state relay output** have been certified to be **IEC 60950** compliant.

The DTS 307 has 3 options for outputting data **depending on the model ordered**:

- Modbus RTU over a 2-Wire RS-485 bus
- BACnet MS/TP over a 2-Wire RS-485 bus
- A kWh Energy Pulse Output through a Potential-Free Normally Open (N.O.) Solid State Relay (SSR).

Do NOT use this output to switch more than 50Vdc.

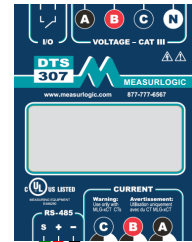

RS-485 2-Wire

+ to +
- to -
S to S



4.1 RS-485 2-Wire Communications

RS-485 is a Daisy Chained Bus terminated at both ends with 120 Ohms. DO NOT use a STAR or RING configuration.

- Use 18-22 AWG, 2-core, shielded, twisted pair cable
- When fitted with **Modbus RTU**, unless otherwise specified through correspondence prior to ordering, the default Modbus RTU communications parameters are as follows:
 - **Modbus Address: 100, Baud Rate: 9600, Parity: None, Data Bits: 8, Stop Bits: 1** (9600, N, 8, 1 #100).
- Modbus parameters can be changed either through **DTS Config** or by writing to specific registers in the meter. Please see the **Modbus Map** document or section 7 for **DTS Config**.
- When fitted with **BACnet MS/TP**, unless otherwise specified through correspondence prior to ordering, the default BACnet MS/TP communications parameters are as follows:
 - **Device Object ID: 473001, MAC Address: 1, Baud Rate: 38400**
BACnet MS/TP requires Parity: None, Data Bits: 8, Stop Bits: 1
- BACnet parameters must be changed via the BACnet interface.

4.2 kWh Pulse Output (Model Dependent)

- The DTS 307 comes with a Digital I/O port that can be configured for pulse outputs.
- The DTS 307 will pulse at 1kWh by default but can be changed using DTS Config.
- The relay closure of each pulse will last for 100ms (pulse width) with a minimum delay of 100ms between any two pulses. **The maximum switching voltage is 50Vdc.**

5 LED Definitions

The DTS 307 is equipped with 2 LEDs useful for diagnostics and troubleshooting – **STATUS** and **REMOTE**.

5.1 Status LED

- The **STATUS** LED consists of a repetition of **two flashes** and shows whether the measured power is being consumed/imported or generated/exported, as well as the magnitude of the total current.
- The **First Flash** is the “heartbeat” and indicates that the meter is ON and the direction of energy:



Green – Energy is being consume/imported



Orange – Energy is being generated/exported

- The Color and Length of the **Second Flash** indicates the “total current level” for all the measured phases relative to the total service current:

- GREEN for 5-80% of total service current
- ORANGE for 80-100% of total service current
- RED for >100% of total service current

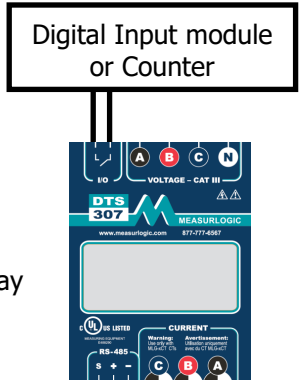
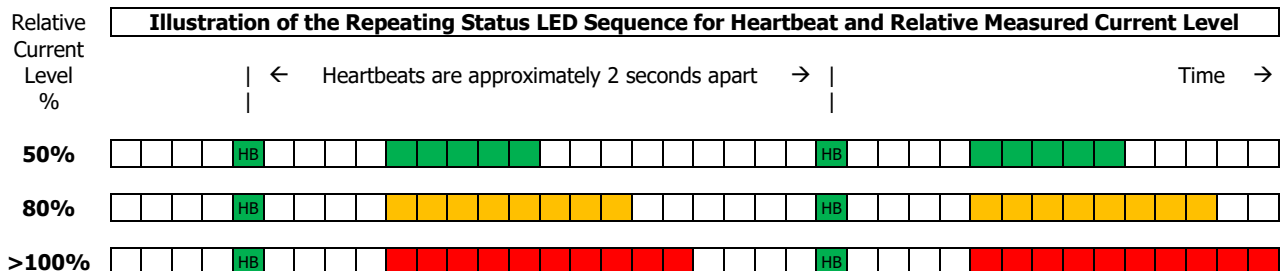

5.2 Remote LED

- The **REMOTE** LED is a communications indicator which is present on all meters fitted with an RS-485 serial port.
- The LED will flicker **GREEN** when the DTS 307 receives data on the BUS and **AMBER** when the DTS 307 transmits data in response.



Green – Data being received



Amber – Data being transmitted

6 INSTALLATION OF DTS CONFIG AND MONITORING SOFTWARE

- **DTS Config** is a program used to easily monitor and configure meters from the DTS family from your local PC or across the LAN.
- Download the latest version of DTS Config from <https://www.measurlogic.com/software-drivers/>. Alternatively, an e-mail can be sent to info@measurlogic.com to request the latest version of DTS Config.
- Unzip the **DTSTConfigSetup** file and double click the **setup.exe** file to begin the installation process.
- Follow the instructions on the screen.

7 MAINTENANCE AND SERVICE



WARNING

There are NO other user serviceable parts in the DTS 307, and no regular maintenance is required. If additional maintenance is needed, please contact Measurlogic Inc.

7.1 Cleaning Instructions

Regular cleaning of the DTS 307 is **NOT** required, but if you do wish to clean the DTS 307, please note the following:

- Before attempting to clean the DTS 307 ensure that all power running to the DTS 307 is removed.
- **Use only a slightly damp cloth to clean the outside of the meter only.**
- Do not use any harsh chemicals or detergents.
- No water or any other liquid must be allowed to enter the meter.
- Do not use a spray bottle.