

MDC-20

Maximum Demand predictive Control



Description

The **MDC-20** is a unit designed to control the maximum demand of an installation. It means that the unit connects and disconnects the installation's electrical loads (non-priority loads) to ensure that the maximum power contracted is not exceeded. Management of the loads is done in accordance with the power rating of the loads, the maximum configured power, and the current energy measured. This system optimises the consumption of energy in the installation because it allows the maximum number of loads to be used simultaneously but does not exceed the contracted power, which would result in high penalties.

The unit is equipped with relay outputs that enable the management of up to 6* electric loads without expanding.

***(It is possible to use the output for some alarms conditions. In this case, the number of free relays to control local loads is 4).**

- Peripheral communications fault alarm
- Insufficient loads for the power control

Enables expansion to manage more loads through units with relay outputs like the LM4I/4O, up to a maximum of 12 units.

Its main features are:

- Demand management by disconnecting up to 6 non-priority local loads.
- Expandable until 54 loads with **12 LM4I/4O** units through the RS-485 port.
- Instantaneous energy value reading through Modbus/RTU communications or the impulse input.
- Synchronising impulse input.
- Ethernet connection to centralize it in other applications or communicating with remote peripherals on the network.
- Feedback load status control through the logic status of the inputs, or by centralising consumptions by impulses.
- Disabling load management according to schedule.
- Simulation tool for verifying system behaviour.

Load Control

- Control of up to 54 loads or load groups.
- Priority configuration load to detect the lower priority loads that can be habitually disconnected, and the higher priority ones that should only be disconnected when is absolutely necessary to avoid exceeding the contracted power.
- Possibility of create load groups with different priority and define the connection/disconnection sequences (FIFO or LIFO).
- Defining up to 6 different states for the loads:
- Active, Inactive, Forced active, Forced inactive, Deactivate by calendar or unknow status (e.g., forced inactive enables us to carry out repairs on a load without worrying about said load being able to be reconnected)
- Real feedback of the load status if the relay that controls the load is wired to one input of the MDC-20.

Modular system

Modular system that can be adjusted to the number of loads in any installation. Communications with remote LM4I/O allows to manage connections / disconnections very near to the loads with the purpose of optimising the system, reducing cable distances and improving response time.

+ LM4I/4O



Technical features

Power Supply	Single-phase	85 ... 264 V _{a.c.} / 120 ... 374 V _{d.c.}
	Frequency	47 ... 63 Hz
	Maximum consumption	5 ... 8 VA
Output features	Type	Relay
	Maximum operating power	740 VA
	Maximum operating voltage	250 V _{a.c.}
	Maximum current commutation	5 A with resistive load
	Electrical working life (250 V _{a.c.} / 5 A)	3 x 10 ⁴ maneuvers
Input features	Mechanical working life	2 x 10 ⁷ maneuvers
	Type	Free-voltage opto isolated
Display	Max. current activation	50 mA
	Isolation	1500 V
Mechanical features	LCD with backlight	
	Box material	UL94 – V0 Self-extinguishing plastic
	Dimensions (mm)	105 x 70 x 90 mm (6 modules)
Network interface	Weight (Kg)	0,280
	Type	Ethernet 10BaseTX
	Connector	RJ-45
Serial Interface	Network protocol	HTTP / Modbus/RTU
	Bus	RS-485
	Type	Three-wire RS-485 (A/B/S)
	Transmission speed	4800, 9600, 19,200, 34,800
Safety	Data bits	57,600, 115,200 bps
	Parity	8
	Stop Bit	Without parity
		1
Standards	Category	CAT III 300/520 V _{c.a.} según EN 61010
	Insulation type	Class II double insulation against electric shock
Standards		IEC 60664, VDE 0110, UL 94, EN 61010-1, EN 55011, EN 61000-4-3, EN 61000-4-11, EN 61000-6-4, EN61000-6-2, EN 61000-6-1, EN 61000-6-3, EN 61000-4-5

Example of an installation managed by **MDC-20**

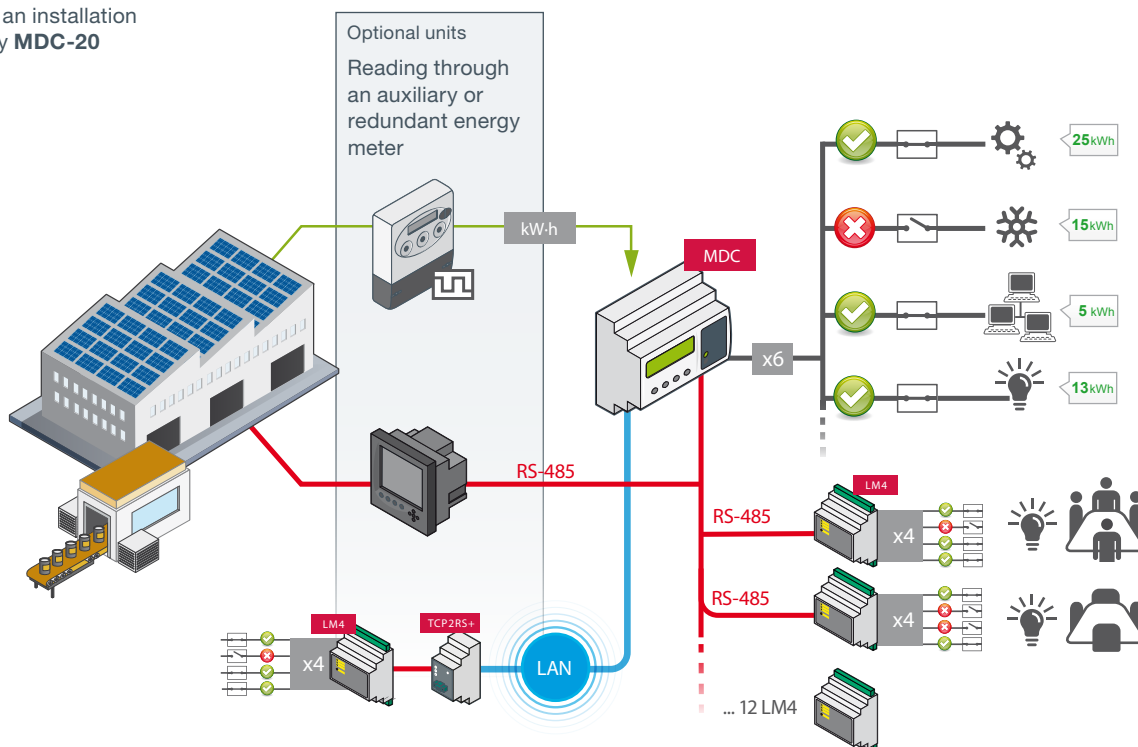

MDC-20

Maximum Demand predictive Control



Software

Programming and management software included to record and visualize the connections and disconnections made by our power control.

Possibility of programming contracted power schedules according to the times of day, type of day, for the current and future years.

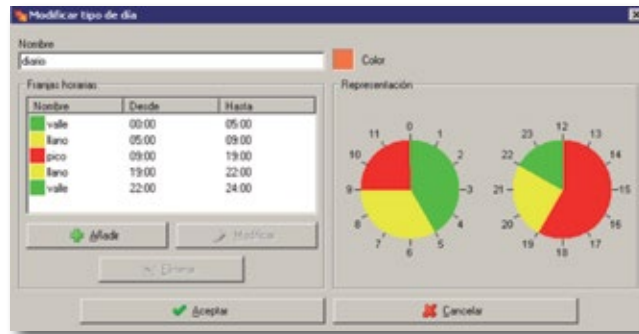

Individual load schedules available not only for automatically running and stop them, also to made a perfect power control by knowing in advance the loads that are functioning. The user defines the basic power control parameters, such as the type of window, integration period, etc.

The user defines the contracted schedule type or the one he wants to meet, as well as the types of days that are going to shape the tariffs that the utility applies.

The software supports different tariffs on different types of days.

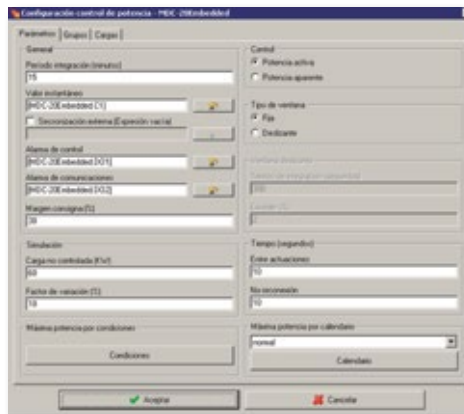

It is possible to program the maximum demand by conditions, that has more priority over the demand programmed by conditions. These conditions can modify the maximum power value.

MDC-20

Maximum Demand predictive Control

It is necessary to define in the application load groups, the disconnection criteria (FIFO or LIFO) for the loads of each group and the disconnection order of each group in relation to the others (depends on the position in the list, the priority will be more or less).

Groups could be created according to the installation (e.g.: compressor group, lighting group, etc.).

The application shows us the groups list, the loads of the selected group, the power of each load, the group total power amount, and the sequence criteria a FIFO or LIFO sequence.

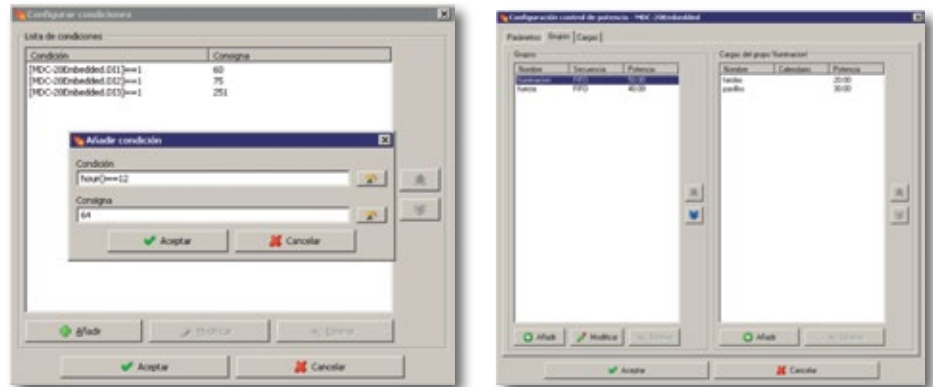

If the load status is wired to the MDC-20 inputs, it is possible to know the permanent state of each load.

After creating the groups, it is necessary to create the loads and define the power of each one the output relay that controls it.

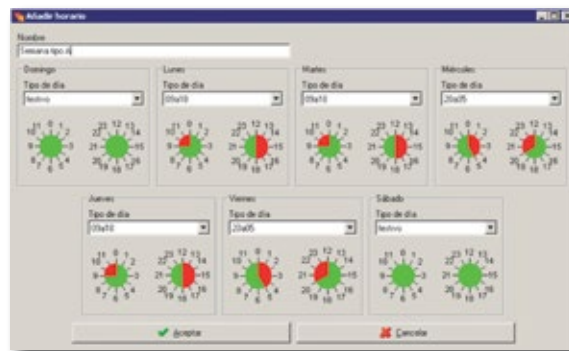

It is possible to create a daily, weekly calendar to disconnect the loads.

An annual schedule can be created too.

For example, we can force a load to remain disconnected during a certain schedule without the option of being connected.

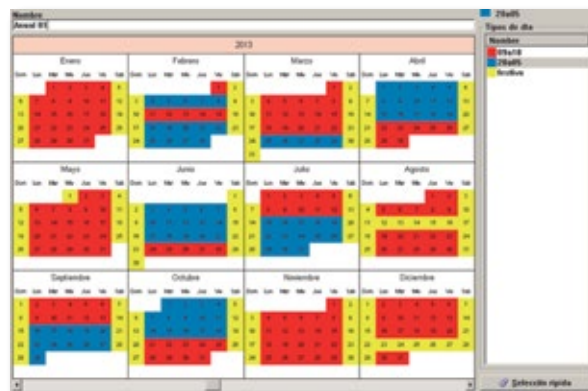





MDC-20

Maximum Demand predictive Control



The system's behaviour can be simulated, tested for proper operating and the final adjustments made.

The Software saves an historical log of the different load behaviours in memory, which can be seen as a graphic. It also possible seeing the load status in real time, manually forcing their state in order to disconnect them or leave them permanently connected. The icon status attached to the loads gives us the information about the real status:

-  **Load connected.** Automatic management determined by programming.
-  **Load disconnected.** Automatic management determined by programming.
-  **Forced load connection.** This load can not be disconnected until it is freed.
-  **Forced load disconnection.** This load can not be connected until it is freed.
-  **Unknown** status due to communication fail.

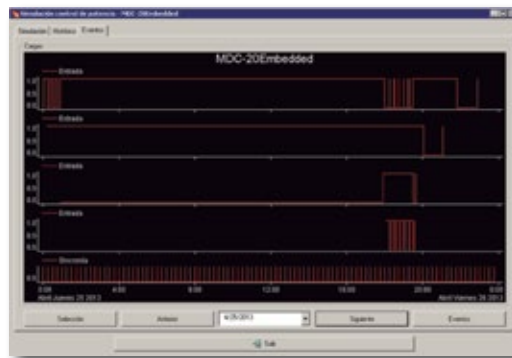
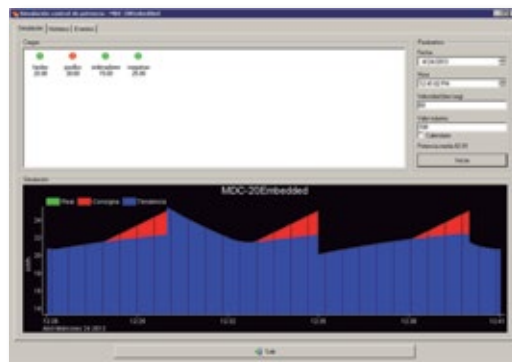

Dimensions

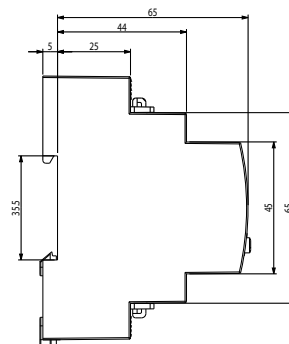
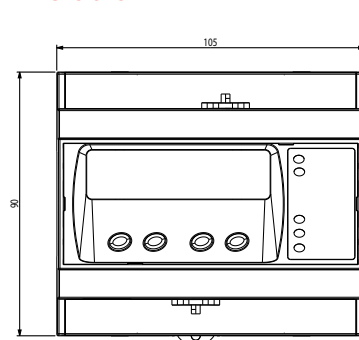

MDC-20

Maximum Demand predictive Control

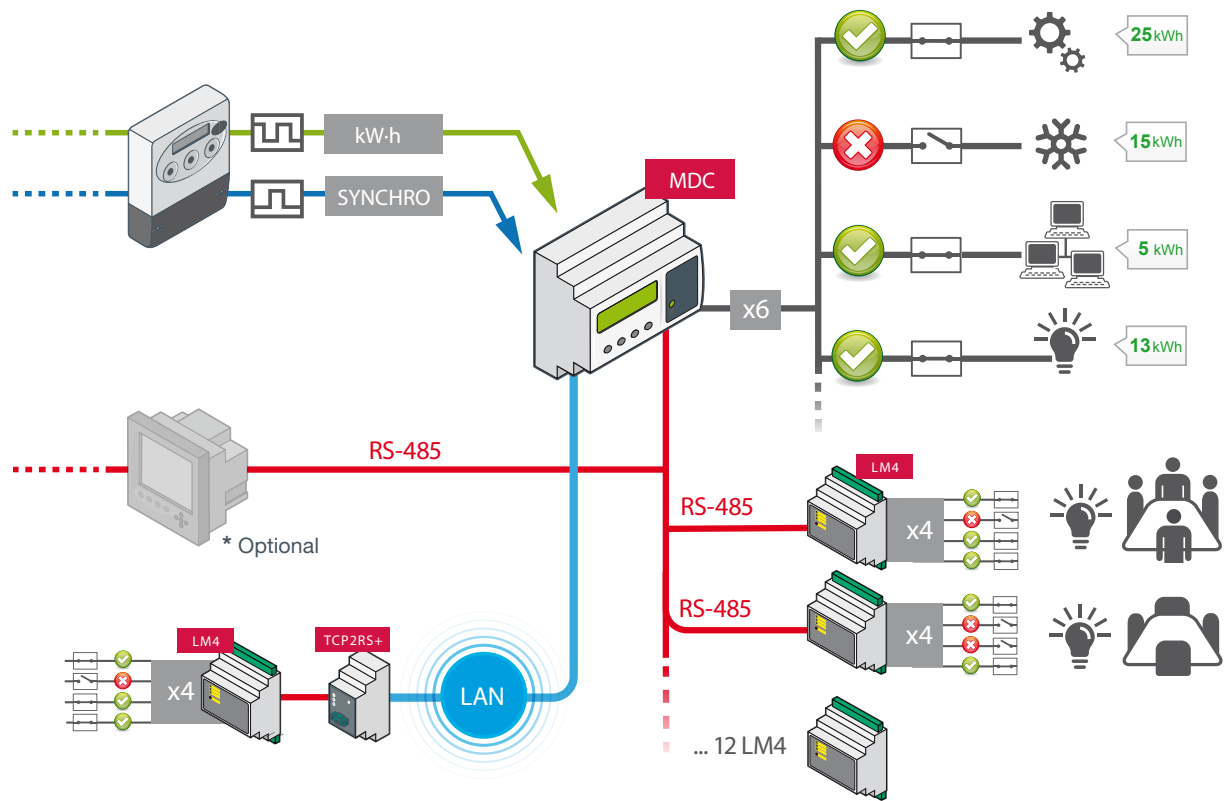

Connections

The connection diagram shows one of the **MDC-20** integration possibilities for carrying out maximum demand control, which means centralising the impulses of a billing energy meter.

The energy impulses provides to the **MDC-20** the instantaneous real consumption of the installation so that the unit, according to the programming, disconnects or connects the loads needed to maintain the maximum quantity of loads connected, ensuring that the maximum demand configured is not going to be exceeded.

Another possibility allowed by the unit is using the synchronising impulse that the main energy meter provides. This enables synchronised operating with the energy meter and not with the **MDC-20** internal clock.

The unit has 6 outputs that can manage 6 loads or 6 load groups. Some of the outputs can also be used for actuating if the unit detects an alarm state.

The unit has 8 inputs that can be used for different functions. For example, it enables configuring the inputs to centralise energy impulses of other consumption analyzers that are not equipped with communications. It is possible to wire the inputs from the auxiliary contact of the relay for the different loads managed by the unit in order to determine the state of the relay that controls the load.