

DTS 307

DIN – Rail Mounted, Ultra-Compact Revenue Grade Electrical Sub-meter



1	PRODUCT OVERVIEW	3
1.1	SUPPLIED ITEMS	4
1.2	DOCUMENT CONVENTIONS	4
1.3	PRODUCT SPECIFICATION	5
1.3.1	<i>Current Inputs</i>	5
1.3.2	<i>Service Type</i>	5
2	INSTALLATION	6
2.1	ENVIRONMENT	6
2.2	SAFETY GUIDELINES	6
2.3	PRODUCT DIMENSIONS	7
2.4	GENERAL MOUNTING REQUIREMENTS AND GUIDELINES	8
2.5	MOUNTING THE DTS 307 IN AN ELECTRICAL PANELBOARD.	10
2.6	STANDALONE MOUNTING OF THE DTS 307.	11
3	CONNECTING TO THE DTS 307	12
3.1	WIRING VOLTAGE AND CURRENT INPUTS	12
3.1.1	<i>Wiring Examples</i>	12
3.2	CONFIGURING THE CURRENT SENSOR TYPE AND RATED CURRENT OF THE CT	14
3.3	CONNECTING MULTIPLE LOADS	16
3.4	AUXILIARY POWER	17
4	DTS 307 COMMUNICATIONS INTERFACE	18
4.1	RS-485 2-WIRE COMMUNICATIONS	18
4.2	KWH PULSE OUTPUT (MODEL DEPENDENT)	19
5	LED DEFINITIONS	19
5.1	STATUS LED	19
5.2	REMOTE LED	20
6	INSTALLATION OF DTS CONFIG AND MONITORING SOFTWARE	20
7	MAINTENANCE AND SERVICE	21
7.1	CLEANING INSTRUCTIONS	21

1 PRODUCT OVERVIEW

The One Revenue Grade Meter for all Applications.

Our DTS 307 or DTS 307/1 energy sub-meter is one of the most versatile meters available on the market.

The standard DTS 307 is a full 3-Phase measurement RGM. If only a single phase 2-Wire system needs to be measured, the single channel DTS 307/1 is also available.

The DTS 307 can operate in any environment, requires no external power source to operate, and works with all UL or ETL listed 333mV current transformers.

For ease of installation, the DTS 307 is designed to be ultra-compact and fit into most DIN-rail systems.

Some of the exciting features provided with the DTS 307 are:

- Easy to attach pluggable terminals.
- Modbus RTU or BACnet MS/TP depending on model.
- Auto-topology Phase Detection.
- Automatic correction of reversed field mounted CTs.

For remote configurability, your DTS 307 comes with our freely downloadable *DTS Config* software tool.

The DTS 307 is certified to ANSI C12.20 Class 0.5 Revenue Grade.

Also, if in the future, you decide to integrate renewable energy sources, the DTS 307 will conveniently operate as a Bi-Directional **NET** meter. Easily integrates with Building Automation Systems and Energy Monitoring Software.

Designed and Manufactured in the USA and complies with the Buy American Provisions of ARRA Section 1605.

Thank you for choosing Measurlogic and a meter from the DTS Family.



NOTE	NOTE
Both the DTS 307 and DTS 307/1 variations will be generically referred to as the "DTS 307" in this document, except where it is important to distinguish between the two models.	Les variantes DTS 307 et DTS 307/1 seront désignées de manière générique sous le nom de "DTS 307" dans ce document, sauf lorsqu'il est important de faire la distinction entre les deux modèles.

1.1 Supplied Items

Check that the meter and equipment match your order specifications and has not been damaged during shipping. Verify that the following item(s) match with the corresponding model from the data sheet:

- Installation Guide
- DTS 307 power & energy meter
- 10-Pin green pluggable screw terminal connector for Voltage and Aux Power/Digital Output
- 6-Pin green pluggable screw terminal connector for Current inputs
- 3-Pin green pluggable screw terminal connector for Remote RS-485 Communications

1.2 Document Conventions

SYMBOLS



ATTENTION	ATTENTION
This section contains information that is important to the operation of the meter.	Cette section contient des informations importantes pour le fonctionnement du compteur.



WARNING	AVERTISSEMENT
This section contains very important safety information to reduce the risk of electrical shock.	Cette section contient des informations de sécurité très importantes pour réduire le risque de choc électrique.

1.3 Product Specification

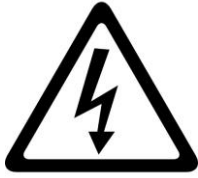

WARNING	AVERTISSEMENT
<p>Measurement Category III</p> <p>DTS 307 is intended for 208Vac to 480Vac L-L use</p> <p>DTS 307/1 is intended for 240Vac L1-L2 use</p> <p>Do NOT exceed this usage</p>	<p>Catégorie de mesure III</p> <p>Le DTS 307 est destiné à une utilisation 208Vac à 480Vac L-L</p> <p>Le DTS 307/1 est destiné à une utilisation 240Vac L1-L2</p> <p>Ne dépassez PAS cette utilisation</p>
<p>Use the model number of the DTS 307 to verify that it is suitable for the voltage, type and category of the installation.</p>	<p>Utilisez le numéro de modèle du DTS 307 pour vérifier qu'il convient à la tension, au type et à la catégorie de l'installation.</p>
<p>Failure to use the correct current transformers, and/or connecting too high a voltage can result in death or personal injury and may permanently damage the DTS meter.</p>	<p>Le fait de ne pas utiliser les transformateurs de courant corrects et/ou de connecter une tension trop élevée peut entraîner la mort ou des blessures corporelles et peut endommager de manière permanente le compteur DTS.</p>

The model number for the normal three-phase DTS 307 is:

DTS 307 - Ax-xx-x-F

For applications where only single channel measurements are needed, the model number is:

DTS 307/1 - Ax-xx-x-F

1.3.1 Current Inputs

Current Inputs	Value	Description	Notes
A	3	333mV CT	Any 333mV CT is acceptable
	9	Rope CT	Only use the CT's that came with the unit

1.3.2 Service Type

Service Type	Value	Description	Neutral Required	Neutral Optional
F	N	(1P 2W, 1P 3W, 3P 4W) 120 – 277Vac L– N	•	
	2	(3P 3/4W) 208 – 240 Vac L– L <i>(for DTS 307)</i> (1P 2W) 120 – 277 Vac L1–L2 <i>(for DTS 307/1)</i>		•
	A	Any of the above services (See 3.4 for details)		•

2 INSTALLATION

2.1 Environment

Operating Temperature:	-31°F to 158°F	(-35°C to 70°C)
Storage Temperature:	-40°F to 185°F	(-40°C to 85°C)
Relative Humidity:	5% to 95%	(non-condensing)
Operating Altitude:	Up to 2,000m	

2.2 Safety Guidelines



WARNING	AVERTISSEMENT
<p>To reduce the risk of electric shock, always open or disconnect circuit from power-distribution system (or service) of building before installing or servicing submetering equipment or current sensors.</p>	<p>Pour réduire le risque de choc électrique, toujours ouvrir ou débrancher le circuit du système de distribution d'énergie (ou service) du bâtiment avant installer ou entretenir des équipements de sous-comptage ou des capteurs de courant.</p>

Always adhere to the following safety guidelines:

- Only qualified personnel or **licensed electricians** should handle the installation. Input voltages to the DTS 307 can be hazardous.
- Follow all applicable local and national electric codes.
- Verify input voltage and current are within thresholds for the specific DTS 307 model. (See Product Specification on page 5)
- **Only Current Transformers that are listed to UL 2808 for use in 250Vac or 600Vac line-to-line circuits (as appropriate for the installation) may be used with this meter.**
- **ONLY USE CURRENT TRANSFORMERS WITH OUTPUTS THAT ARE COMPATIBLE WITH THE MODEL OF DTS 307 (SEE SECTION 1.3.1). THE USE OF ANY OTHER CURRENT TRANSFORMER CAN RESULT IN PERMANENT DAMAGE TO THE DTS 307.**
- Avoid any electrostatic discharge prior to working on the DTS 307 by first touching a grounded structure prior to handling the DTS 307.
- Before applying power make sure that all current transformer and voltage connections are securely connected to the input terminals of the DTS 307.
- If the DTS 307 is installed incorrectly any built-in safety features may no longer be functional.
- Before handling the DTS 307 ensure that all power running to the DTS 307 is removed.
- The DTS 307 MUST be mounted in a NEC compliant enclosure suitable for the application's environmental conditions.

- The DTS 307 may be used outdoors if housed in an outdoor rated enclosure that prevents water ingress, such as a NEMA Type 3R / IP14 or higher that is suitably rated for the application.
- The enclosure must be equipped with a **user supplied lock** or other means to prevent unauthorized access.

2.3 Product Dimensions

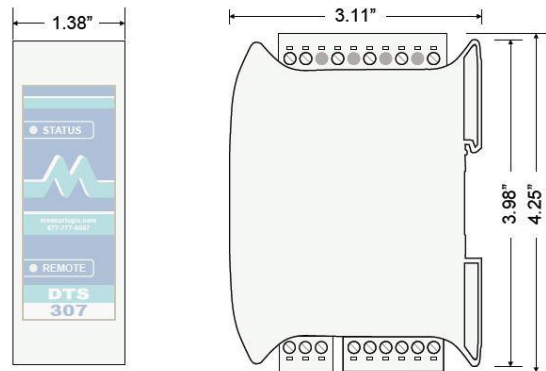

2.4 General Mounting Requirements and Guidelines

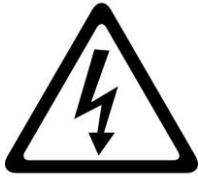

WARNING	AVERTISSEMENT
<p>To reduce the risk of electric shock, always open or disconnect circuit from power-distribution system (or service) of building before installing or servicing submetering equipment or current sensors.</p>	<p>Pour réduire le risque de choc électrique, toujours ouvrir ou débrancher le circuit du système de distribution d'énergie (ou service) du bâtiment avant installer ou entretenir des équipements de sous-comptage ou des capteurs de courant.</p>

When mounting the DTS 307 make sure to follow these guidelines:

- Always completely de-energize the electrical panelboard, switchboard, industrial control equipment and/or energy monitoring management equipment before installing or servicing the DTS 307 meter and/or its Current Transformers.
- See section 2.2 above for further safety information.
- Make sure that there is sufficient clearance above and below the DTS 307 for wiring and connector clearance.
- Position the DTS 307 such that the labeling can be read from the upright position.
- Only UL or ETL rated conduits and glands should be used.
- It is recommended that two separate conduits be run for voltage conductors and current sensors leads.
- Use Copper Conductors ONLY.
- Only Current Transformers that are listed to UL 2808 for use in 250Vac or 600Vac line-to-line circuits (as appropriate for the installation) may be used with this meter.
- The Current Transformers may NOT be installed in equipment where they exceed 75% of the wiring space of any cross-sectional area within the equipment.
- Current Transformer may NOT be installed in areas where they would block ventilation openings.
- Current Transformer may NOT be installed in areas of breaker arc venting.
- Current Transformers must be secured, and their conductors routed so that they do not directly contact live terminals or buses.
- DTS 307 meters that have an "A" in the Service Type field of the model number (as shown in section 1.3.2) are powered through the 24Vac/dc auxiliary terminals. An external IEC 60950 compliant Class 2 isolated power supply and associated wiring methods must be used for this powering option only. Please see Section 3.4 for further details.

- **User Supplied** UL or ETL certified 2A fast-blow fuses need to be installed between the Voltage inputs of the DTS 307 and the panel being monitored. Recommended Littelfuse BLS002 or equivalent. The Measurlogic inline fuse kit can be used for this purpose. (See the Measurlogic webpage at <https://www.measurlogic.com/product/inline-fuse-kit/> for details).
- A UL or ETL certified 600V circuit-breaker must be installed as a disconnecting device for the DTS 307 and must be positioned within easy reach of the DTS 307. The circuit-breaker employed for this disconnecting device shall meet the relevant requirements of IEC 60947-1 and IEC 60947-3, be suitable for the application, and **MUST** be clearly marked as being **"the disconnecting device"** for the DTS 307. See table below for the wire gauge to use for the breaker rating.

WIRE & BREAKER GUIDE	
Gauge of Wire	Recommended Breaker
18 AWG	5 Amp 600V 3-Pole Breaker
14 AWG	15 Amp 600V 3-Pole Breaker
12 AWG	20 Amp 600V 3-Pole Breaker

2.5 Mounting the DTS 307 in an Electrical Panelboard.

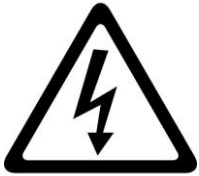

WARNING	AVERTISSEMENT
<p>To reduce the risk of electric shock, always open or disconnect circuit from power-distribution system (or service) of building before installing or servicing submetering equipment or current sensors.</p>	<p>Pour réduire le risque de choc électrique, toujours ouvrir ou débrancher le circuit du système de distribution d'énergie (ou service) du bâtiment avant installer ou entretenir des équipements de sous-comptage ou des capteurs de courant.</p>

The DTS 307 is UL 2808-2020 certified to be mounted inside an electrical panelboard, switchboard, industrial control equipment and/or energy monitoring management equipment.

The following applies when mounting a DTS 307 inside any type of Electrical Panelboard:

- All the requirements and guidelines outlined in Section 2.4 above apply in addition to those below.
- The submetering equipment shall NOT be mounted within 50.8 mm (2 in) of any live parts including primary conductors, primary terminals, primary lugs. This requirement excludes insulated cables.
- Submeters attached to the enclosure shall NOT contact the panel interior insulation.
- Mounting provisions shall NOT be attached to any live part.
- Voltage sensing and power supply connections to the primary voltage shall have overcurrent protection.
- Do not install submetering equipment in any area where breaker arc venting exhaust gasses could be re-directed as a result of submetering equipment installation.
- The DTS 307 meter may NOT be installed in equipment where it exceeds 75% of the wiring space of any cross-sectional area within the equipment.
- If possible, the DTS 307 should be securely fastened in the electrical panelboard, switchboard, industrial control equipment and/or energy monitoring management equipment. The Measurlogic right angle DIN rail bracket CHWR-0200A can be used to mount the DTS 307 meter (See the Measurlogic webpage at <https://www.measurlogic.com/product/right-angle-mounting-bracket/> for details).

2.6 Standalone Mounting of the DTS 307.



WARNING	AVERTISSEMENT
<p>To reduce the risk of electric shock, always open or disconnect circuit from power-distribution system (or service) of building before installing or servicing submetering equipment or current sensors.</p>	<p>Pour réduire le risque de choc électrique, toujours ouvrir ou débrancher le circuit du système de distribution d'énergie (ou service) du bâtiment avant installer ou entretenir des équipements de sous-comptage ou des capteurs de courant.</p>

The following applies when mounting a DTS 307 in a standalone application:

- All the requirements and guidelines outlined in Section 2.4 above apply in addition to those below.
- The DTS 307 must be mounted in an enclosure that is appropriately rated for environmental conditions where it is mounted.
- Mount the enclosure containing the DTS 307 as close as possible to the electrical panel being monitored, so that it is within easy reach of the electrical disconnect breaker.
- The DTS 307 may be used outdoors if housed in an outdoor rated enclosure that prevents water ingress, such as a NEMA Type 3R / IP14 or higher that is suitably rated for the application.

3 CONNECTING TO THE DTS 307

3.1 Wiring Voltage and Current Inputs



ATTENTION	ATTENTION
Examine the model number of each of your meters to ensure that they are suitable for the type and voltage of the service you are connecting to. See section 1.3 for details.	Examinez le numéro de modèle de chacun de vos compteurs pour vous assurer qu'ils conviennent au type et à la tension du service auquel vous vous connectez. Voir rubrique 1.3. pour plus de détails.
Current transformers should be connected to the same panel as the voltage connections.	Les transformateurs de courant doivent être connectés au même panneau que les connexions de tension.

3.1.1 Wiring Examples

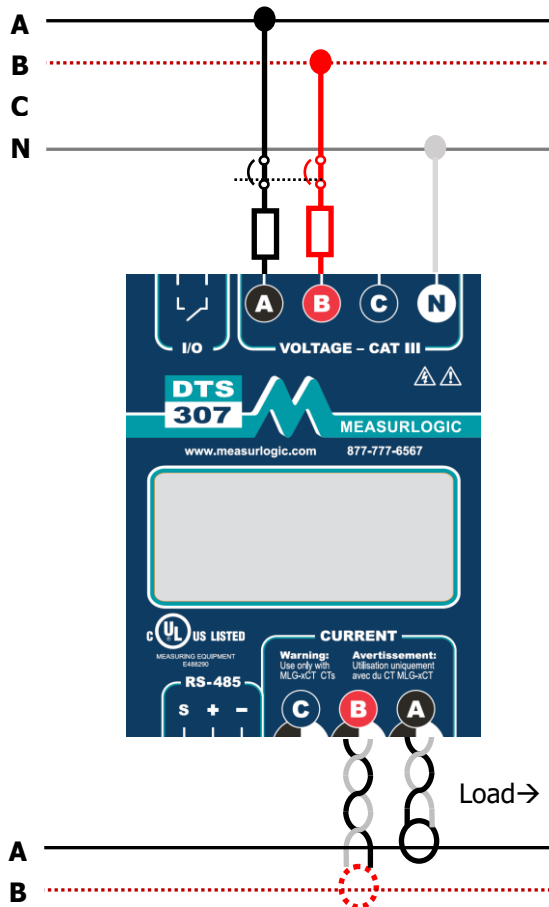

DTS 307
Single Phase 2/3 Wire

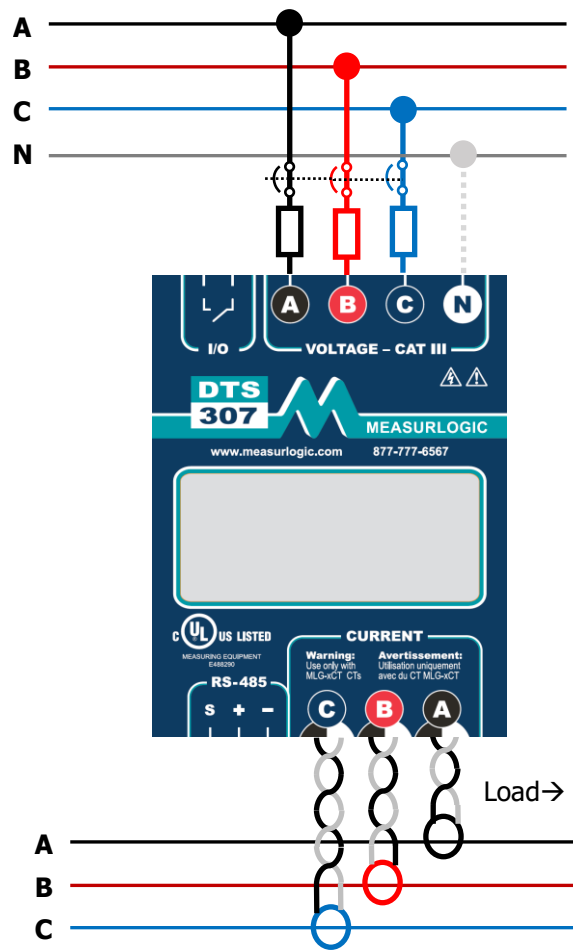

DTS 307
3-Phase with Optional Neutral
(Model Dependent)

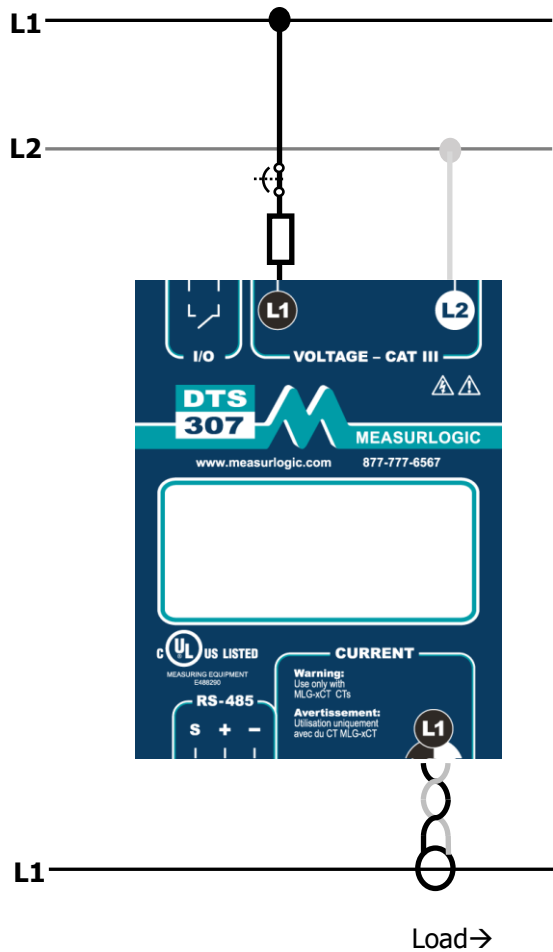

DTS 307/1
Single Phase 2-Wire ONLY

3.2 Configuring the Current Sensor Type and Rated Current of the CT



ATTENTION	ATTENTION
<p>The DTS 307 meter only supports 333mV and Rogowski Coil CTs. DO NOT attempt to connect a 5A secondary CT to the DTS 307, as this will result in damage to the DTS 307 and the CT.</p>	<p>Le compteur DTS 307 ne prend en charge que les TC à bobine de 333 mV et Rogowski. N'essayez PAS de connecter un TC secondaire de 5A au DTS 307, car cela entraînerait des dommages au DTS 307 et au TC.</p>

The **DTS 307-3x-Sx-x-x** meters are compatible with the following current sensors:

- **333mV Output CTs** – This type of current sensor is internally burdened so that the voltage output is 333mV for the current rating that is specified on the CT itself. The current rating of the CT must be specified when ordering and cannot be changed in the field. The Rated Current of the CT as it appears on the CT label **MUST** be configured in the DTS 307 Meter.
- **Rogowski Coil CTs** – This is a flexible CT. Measurlogic DTS meters can accept Rogowski Coil CTs directly **without** the need for an external integrator. The sensitivity of this type of current sensor is specified in milli-volts (mV) per 1000A at 60Hz. Different models of Rogowski Coils have different sensitivities, which must be selected from the pull-down menus in DTS Config and set accordingly. The CT Rating that is set does not affect the current measurement values. We recommend that you set the CT Rating in the meter to the panel rating, or the expected nominal current being measured.
- **Rogowski Coil CTs (with an external integrator)** – Measurlogic DTS meters can accept Rogowski Coil CTs directly connected to the DTS 307 meter, so an external integrator module is NOT required. However, if the system already has an external integrator module installed, then the output of the integrator will be 333mV for the current specified on the integrator label. For such systems, the DTS 307 meter must be configured for a “333mV” input. The Rated Current as it appears on the integrator label **MUST** be configured in the DTS 307 Meter.

NOTE
<p>If multiple CTs per phase are required, please see section 3.3 below for a 333mV CT example. Our document “Using Multiple CT Sets with DTS Meters” in the “Technical” section of the DTS 307 webpage at https://www.measurlogic.com/product/dts-307/ contains more detailed information regarding multiple 333mV and Rogowski Coil CT applications.</p>

Configuring the Electrical Settings using DTS Config

Select "Configure" from the menu. The "Electrical Settings" can be found in the "User" tab for DTS Config V1.47.0.291 or earlier. DTS Config V1.48.0.295 and later has split the "Electrical Settings" and "Communications Settings" into two separate tabs.

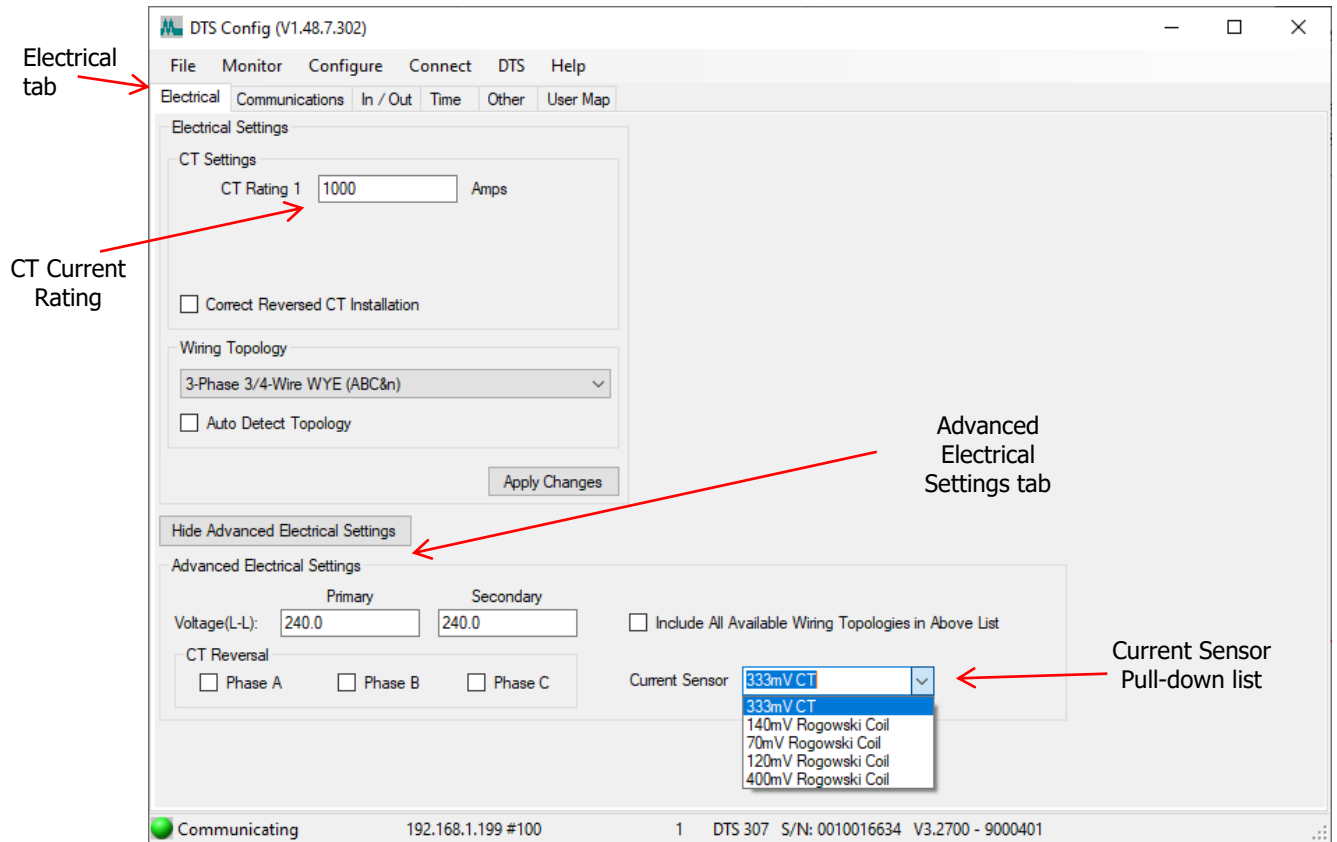

Configuring 333mV output CTs

- Set the CT Rating of the CTs that are being used.
- Ensure that the "Current Sensor" type in the "Advanced Electrical Settings" is set to "333mV CT".

Configuring Rogowski Coil CTs

- Set the CT Rating to the panel rating, or the expected nominal current being measured. This value does not affect the current measurement values.
- Select a Rogowski Coil option from the "Current Sensor" drop down list in the "Advanced Electrical Settings" that matches the output of the Rogowski Coils being used, as this directly affects the current measurement values.

Voltage(L-L) Primary and Secondary settings

- **Low Voltage Applications:** Do NOT change the Voltage(L-L) Primary and Secondary settings. These two numbers MUST be the same values for correct operation. The ratio must be 1:1.
- **Medium or High Voltage Applications (with external PTs):** The Voltage(L-L) Primary and Secondary settings MUST be set according to the primary and secondary ratings of the external PTs.

3.3 Connecting Multiple Loads

The DTS 307 allows for ease and flexibility when monitoring multiple branches. The DTS 307 allows multiple CT sensors to be connected in parallel via the green pluggable screw terminal.

When using parallel CT sensors, the following guidelines must be followed to ensure accurate measuring.

- All CT sensors must have a 333mV output.
- All CT sensors must be of the same manufacturer/model number and current rating.
- A full set of CT sensors must be used for each load.
- The pair of wires from the CT sensor to the green pluggable screw terminal must be twisted.
- All CT sensors must be terminated at the green pluggable screw terminal.
- The measured phase current will be the total current across all the loads on that phase.
- The CT primary rating for the DTS 307 must be set to the **CT rating * Number of CT sets**.
- The example below shows how to calculate the service current for figure 3.2.1.
- A maximum of 3 loads can be monitored at once (Contact Measurlogic if more than 3 loads must be monitored).

Service Current for Figure 3.2.1	
Number of CT Sensor Sets	2
CT Rating	100 Amps
CT Primary	200 Amps

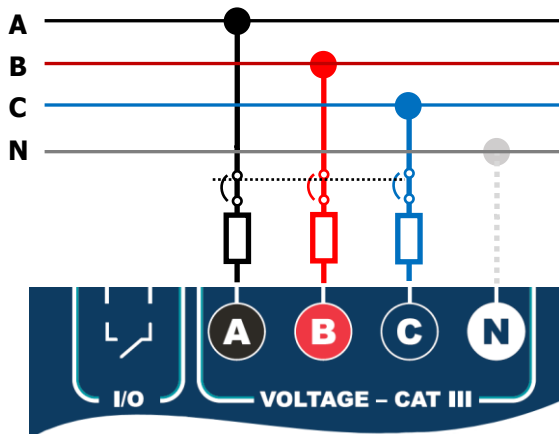
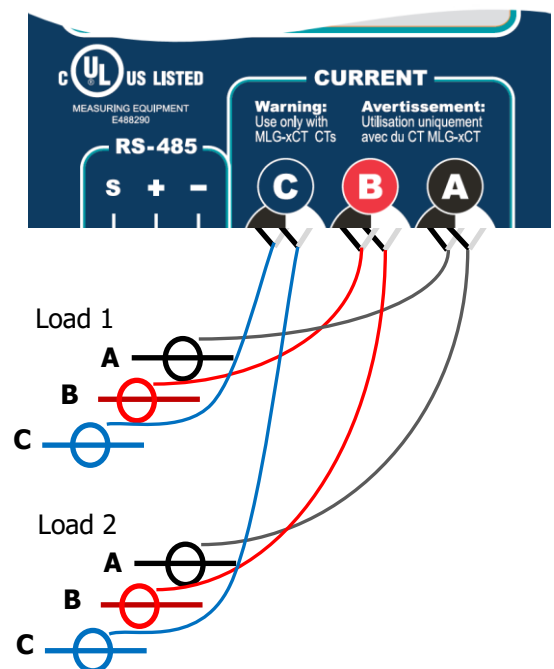

Figure 3.2.1



3.4 Auxiliary Power



ATTENTION	ATTENTION
DTS 307 meters that have an "A" in the Service Type field of the model number (as shown in section 1.3.2) require an external 24Vac/dc auxiliary power supply to operate.	Les compteurs DTS 307 qui ont un "A" dans le champ Type de service du numéro de modèle (comme indiqué dans la section 1.3.2) nécessitent une alimentation auxiliaire externe 24Vac/dc pour fonctionner.
A separate IEC 60950 compliant isolated 24Vac/dc Class 2 power supply must be used to power these meters.	Une alimentation séparée 24Vac/dc Classe 2 isolée conforme à la norme CEI 60950 doit être utilisée pour alimenter ces compteurs.

- Connect the external IEC 60950 compliant Class 2 isolated power supply to the two 24Vac/dc terminals on the DTS 307 meter as shown on the meter label and in the diagram below.
- For clarity, the meter voltage terminal and the CT sensors connections are not shown on the diagram below. Please see sections 3.1 and 3.3 for these connection details.

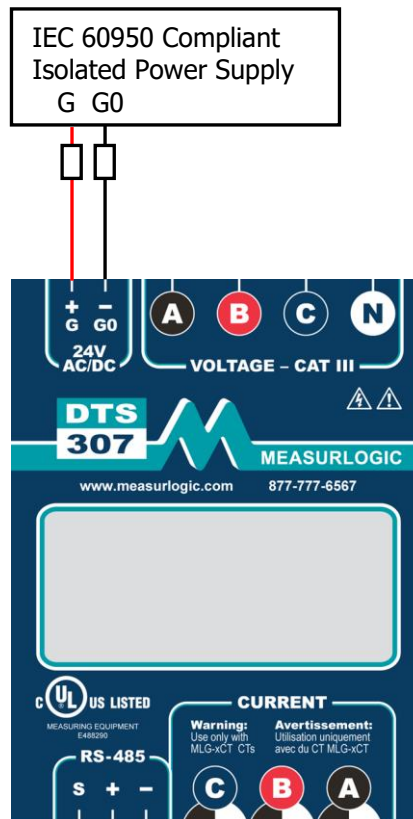

4 DTS 307 COMMUNICATIONS INTERFACE



WARNING	AVERTISSEMENT
Ensure that all external devices that are connected to either or both of the RS-485 communications bus, and/or the digital solid state relay output have been certified to be IEC 60950 compliant.	Assurez-vous que tous les périphériques externes connectés à l'un ou l'autre des bus de communication RS-485 et/ou à la sortie de relais numérique à semi-conducteurs ont été certifiés conformes à la norme CEI 60950.

The DTS 307 has 3 options for outputting data **depending on the model ordered**:

- Modbus RTU over a 2-Wire RS-485 bus
- BACnet MS/TP over a 2-Wire RS-485 bus
- A kWh Energy Pulse Output through a Potential-Free Normally Open (N.O.) Solid State Relay (SSR).

Do NOT use this output to switch more than 50Vdc.

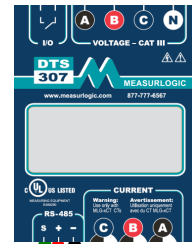

RS-485 2-Wire

+ to +
- to -
S to S

4.1 RS-485 2-Wire Communications

RS-485 is a Daisy Chained Bus terminated at both ends with 120 Ohms. DO NOT use a STAR or RING configuration.

- Use 18-22 AWG, 2-core, shielded, twisted pair cable
- When fitted with **Modbus RTU**, unless otherwise specified through correspondence prior to ordering, the default Modbus RTU communications parameters are as follows:
 - **Modbus Address: 100, Baud Rate: 9600, Parity: None, Data Bits: 8, Stop Bits: 1** (9600, N, 8, 1 #100).
- Modbus parameters can be changed either through **DTS Config** or by writing to specific registers in the meter. Please see the **Modbus Map** document or section 7 for **DTS Config**.
- When fitted with **BACnet MS/TP**, unless otherwise specified through correspondence prior to ordering, the default BACnet MS/TP communications parameters are as follows:
 - **Device Object ID: 473001, MAC Address: 1, Baud Rate: 38400**
BACnet MS/TP requires Parity: None, Data Bits: 8, Stop Bits: 1
- BACnet parameters must be changed via the BACnet interface.



4.2 kWh Pulse Output (Model Dependent)

- The DTS 307 comes with a Digital I/O port that can be configured for pulse outputs.
- The DTS 307 will pulse at 1kWh by default but can be changed using DTS Config.
- The relay closure of each pulse will last for 100ms (pulse width) with a minimum delay of 100ms between any two pulses. **The maximum switching voltage is 50Vdc.**

5 LED Definitions

The DTS 307 is equipped with 2 LEDs useful for diagnostics and troubleshooting – **STATUS** and **REMOTE**.

5.1 Status LED

- The **STATUS** LED consists of a repetition of **two flashes** and shows whether the measured power is being consumed/imported or generated/exported, as well as the magnitude of the total current.
- The **First Flash** is the “heartbeat” and indicates that the meter is ON and the direction of energy:



Green – Energy is being consume/imported



Orange – Energy is being generated/exported

- The Color and Length of the **Second Flash** indicates the “total current level” for all the measured phases relative to the total service current:

- GREEN for 5-80% of total service current
- ORANGE for 80-100% of total service current
- RED for >100% of total service current

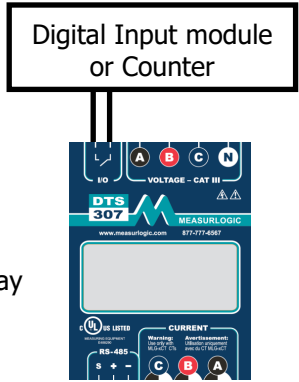
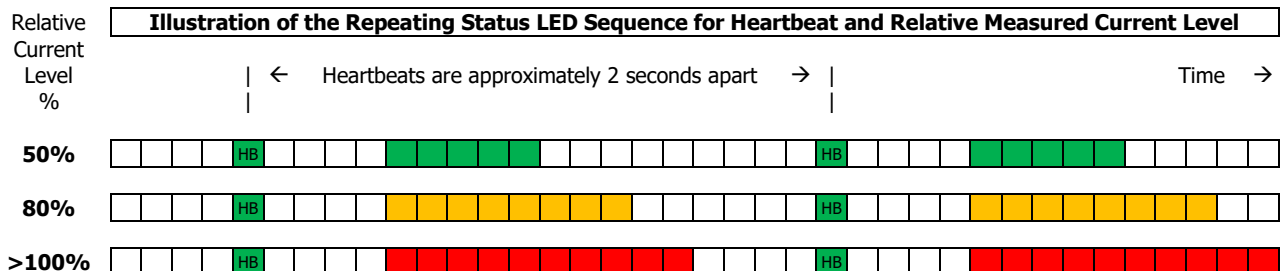

5.2 Remote LED

- The **REMOTE** LED is a communications indicator which is present on all meters fitted with an RS-485 serial port.
- The LED will flicker **GREEN** when the DTS 307 receives data on the BUS and **AMBER** when the DTS 307 transmits data in response.



Green – Data being received



Amber – Data being transmitted

6 INSTALLATION OF DTS CONFIG AND MONITORING SOFTWARE

- **DTS Config** is a program used to easily monitor and configure meters from the DTS family from your local PC or across the LAN.
- Download the latest version of DTS Config from <https://www.measurlogic.com/software-drivers/>. Alternatively, an e-mail can be sent to info@measurlogic.com to request the latest version of DTS Config.
- Unzip the **DTSTConfigSetup** file and double click the **setup.exe** file to begin the installation process.
- Follow the instructions on the screen.

7 MAINTENANCE AND SERVICE

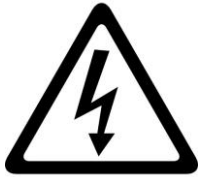

WARNING	AVERTISSEMENT
<p>There are NO other user serviceable parts in the DTS 307, and no regular maintenance is required. If additional maintenance is needed, please contact Measurlogic Inc.</p>	<p>Il n'y a AUCUNE autre pièce réparable par l'utilisateur dans le DTS 307, et aucun entretien régulier n'est requis. Si une maintenance supplémentaire est nécessaire, veuillez contacter Measurlogic Inc.</p>

7.1 Cleaning Instructions

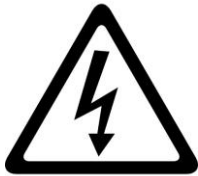

WARNING	AVERTISSEMENT
<p>To reduce the risk of electric shock, always open or disconnect circuit from power-distribution system (or service) of building before installing or servicing submetering equipment or current sensors.</p>	<p>Pour réduire le risque de choc électrique, toujours ouvrir ou débrancher le circuit du système de distribution d'énergie (ou service) du bâtiment avant installer ou entretenir des équipements de sous-comptage ou des capteurs de courant.</p>

Regular cleaning of the DTS 307 is **NOT** required, but if you do wish to clean the DTS 307, please note the following:

- Before attempting to clean the DTS 307 ensure that all power running to the DTS 307 is removed.
- **Use only a slightly damp cloth to clean the outside of the meter only.**
- Do not use any harsh chemicals or detergents.
- No water or any other liquid must be allowed to enter the meter.
- Do not use a spray bottle.